

EN

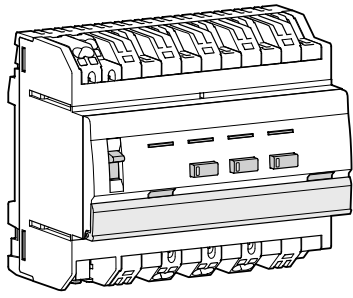

6LE000393C



TYA663AN

Dimmer 3gang

TXA663A

Dimmer 3gang



Safety instructions

EN

Electrical equipment may only be installed and assembled by a qualified electrician in accordance with the relevant installation standards, guidelines, regulations, directives, safety and accident prevention regulations of the country.

Failure to comply with these instructions may result in damage to the device, fire or other hazards.

Hazard due to electric shock. Disconnect before working on the device or replacing illuminants. Take into account all circuit breakers that supply dangerous voltages to the device.

Hazard due to electric shock. The device is not suited for safe disconnection of the mains supply. Even when the device is switched off, the load is not galvanically separated from the mains supply.

Hazard due to electric shock on the SELV or PELV installation. Do not connect any loads for low voltage SELV, PELV or FELV together.

Do not connect any LED or compact fluorescent lamps that are not expressly suitable for dimming. The device could get damaged.

Do not connect lights with integrated dimmer.

Do not connect capacitive load and inductive loads together on the output.

The permissible maximum load per device must not be exceeded.

These instructions are an integral component of the product and must be retained by the end user.

Design and layout of the device

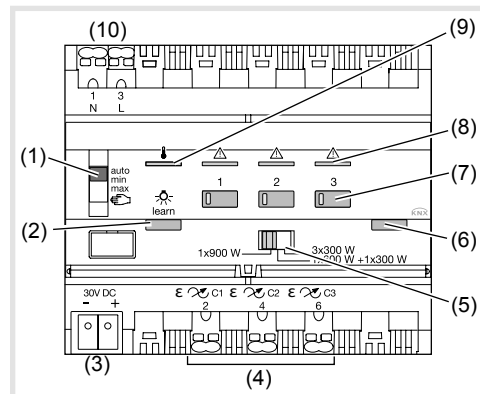

Figure 1: device overview

- (1) Slide switch **auto/min/max/manu**
- (2) Illuminated button for dimming mode
- (3) KNX bus connection terminal
- (4) Connection of loads
- (5) Slide switch channel selection
- (6) Illuminated programming button
- (7) Operation button for manual operation with status LED
- (8) Control LED short-circuit and overload protection per output
- (9) Control LED overheating protection
- (10) Mains connection

Function

System information

This device is a product of KNX system and corresponds to the KNX guidelines. Detailed specialised knowledge obtained from KNX training courses is required for comprehension. The planning, installation and commissioning of the device is carried out with the help of KNX-certified software.

Systemlink commissioning

The function of the device is software-dependent. The software is to be taken from the product database. You can find the latest version of the product database, technical descriptions as well as conversion and additional support programmes on our website.

Easylink commissioning

The function of the device is configuration-dependent. The configuration can also be done using devices developed specially for simple setting and start-up.

This type of configuration is only possible with devices of the easylink system. Easylink stands for easy, visually supported start-up. Preconfigured standard functions are assigned to the in/outputs by means of a service module.

Functional description

The device has three load outputs that can be combined variably using a slide switch to increase loads. It works with automatic load detection depending on the connected load in the phase cut-on or phase cut-off and enables switching and dimming via the KNX bus of:

- incandescent lamps and halogen lamps.
- Low-voltage halogen lamps with conventional or electronic transformer.
- Dimmable LED and energy-saving lamps.

Additionally, the device has a learn function for more efficient control of energy-saving lamps and 230 V LED lamps.

Correct use

- Dimming of electric consumers AC 230 V.
- Installation on DIN rail according to DIN EN 60715 in distribution box

Product characteristics

- Status display of the outputs on the device.
- Manual activation of the outputs on the device is possible, building site operation.
- Automatic load detection.
- Setting the minimum and maximum dimming value.
- Timer functions.
- Scene function.
- Forced position by higher-level controller.

Short-circuit and overload protection

Short-circuit and overload are signalled via the control LED (8). The load is throttled (see Troubleshooting).

Overheating protection

Overheating of the device is signalled by a permanent light of the control LED (9). The connected load is throttled (see Troubleshooting).

Operation

Manual operation

Bus or mains power supply is present.

- Push switch (1) to position .

The manual operation is switched on, the outputs can be controlled using the operation buttons (7).

I During manual operation, the controller is deactivated via the KNX bus.

I Systemlink commissioning: depending on the programming, the manual operation is activated permanently or for a time period configured via the application software. If the manual operation is disabled via the application software, no activation takes place.

Or

- Move switch (1) to position **auto**.

The manual operation is switched off. Operation takes place solely via the KNX bus. The output has the brightness predefined by the bus controller.

Operating outputs in manual operation

Operation takes place by a short or long press on the operation button (7) (table 1).

I If the integrated LED flashes when pressing the operation button, no load is connected.

Status	Performance when pressing the button
Load is switched off. Status LED of the button (7) is off.	Short press on button: Switch ON the connected load. LED lights up. Long press on button: Dim up to maximum brightness. Status LED of button (7) lights up.
Load is switched on. Status LED of the button (7) lights up.	Short press on button: Switch OFF the connected load. Status LED of button (7) goes out. Long press on button: Changes the current brightness. Dimming takes place in the opposite direction of the last dimming operation until maximum or minimum brightness.

Table 1: manual operation

Information for electricians

Installation and electrical connection



DANGER!

Touching live parts can result in an electric shock!

An electric shock can be lethal!

Disconnect the connecting cables before working on the device and cover all live parts in the area!



CAUTION!

Impermissible heating if the load of the device is too high!

The device and the connected cables may get damaged in the connection area!

Do not exceed the maximum current carrying capacity!

I Observe temperature range. Provide sufficient cooling.

- Mount device onto DIN rail in accordance with DIN EN 60715.

Connect device

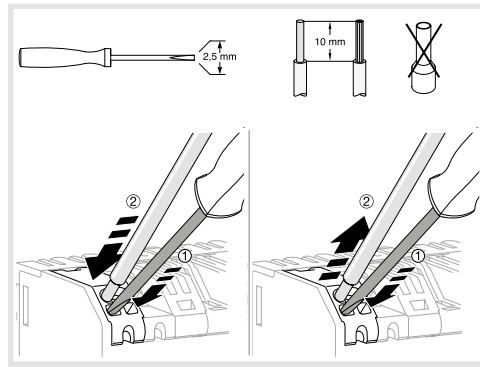

Fig 2: installation/deinstallation with plug-in terminals

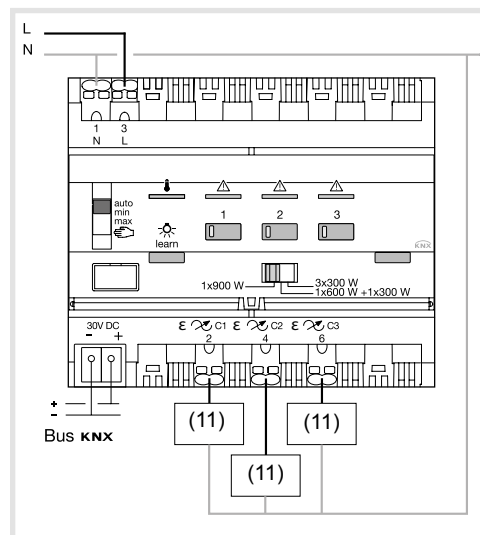
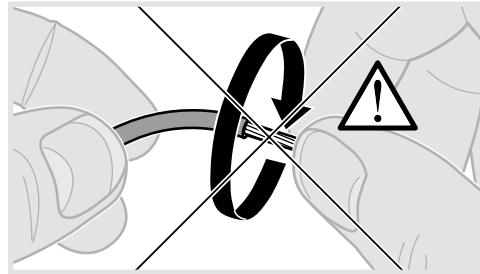

Fig 3: device connection

(11) Load

- Connect bus cable via connecting terminal (3).
- Connect load (11) on the lower terminal strip (4) of the device.

Start-up

Systemlink: loading physical address and application software

The switch for manual operation (1) is in position auto.

- Switch on bus voltage.
- Press programming button (5).
The button lights up.

I If the button does not light up, no bus voltage is present.

- Load the physical address into the device.
Status LED of the button goes out.
- Load application software.
- Note down the physical address on the device.

Easylink

Information on the system configuration can be taken from the extensive description of the service module easylink.

Starting up the device

- Switch on mains supply.

Functional test

The functionality of the outputs is displayed via the status LED of the operation buttons (7).

LED status	Meaning of the signal
LED lights up permanently	Load is activated
LED flashes	No load connected

Selecting the number of outputs using slide switch

The outputs can be combined variably by adjusting the slide switch (5) in order to control the higher loads.

- Select the number of outputs using the slide switch (Table 2).

Load type	Number of outputs	Position of the slider switch (5)		
		1	2	3
Incandescent lamps, halogen lamps 230 V	C1	900 W	600 W	300 W
	C2		300 W	300 W
	C3			300 W
Conventional transformer.	C1	900 VA	600 VA	300 VA
	C2		300 VA	300 VA
	C3			300 VA
Electronic transformer.	C1	900 W	600 W	300 W
	C2		300 W	300 W
	C3			300 W
Dimmable energy-saving lamps (CFL)	C1	210 W	120 W	60 W
	C2		60 W	60 W
	C3			60 W
Dimmable LED lamps	C1	210 W 15 lamps	120 W 15 lamps	60 W 8 lamps
	C2		60 W 8 lamps	60 W 8 lamps
	C3			60 W 8 lamps

Table 2: Number of outputs and installed load

Setting minimum and maximum dimming value on the device

The device is ready for operation.

- Setting brightness value.

I The brightness value can be set by manual operation on the device or by the programmed dimming button of an operating unit.

- Set switch (1) to max. in order to apply the set brightness as maximum dimming value.

Or

- Set switch (1) to min. in order to apply the set brightness as minimum dimming value.
- Keep the operation button (7) pressed for more than 3 s.

The status LED flashes twice. The set brightness value is saved.

I If the minimum or maximum dimming value are outside the setting range, the status LED (7) flashes permanently after the save operation.

Setting dimming mode on the device

In the factory setting, the device performs an automatic load detection for ohmic, inductive and capacitive loads and selects the suitable dimming performance. If the load type is known, this can be specified on the device without performing an automatic load detection.

The device is ready for operation.

- Keep the dimming mode button (2) pressed until its own illumination flashes.
- Select the channel for which you wish to change the dimmer mode by pressing on button (7).
- Briefly press the dimming mode button (2) repeatedly until the coloured lighting of the button (2) displays the desired operating mode (Table 3).
- Keep the dimming mode button (2) pressed until the lighting of the button (2) flashes quickly. While the button is flashing quickly, the selected operating mode is set. After that, the operating mode is displayed for approx. 3 s before the button goes out.

I If the setting is not confirmed by holding down the button, the device will revert to its previous dimming mode after 2 minutes.

I If the operating mode selected is not suitable for the connected load, the dimming channel will reset to „factory setting“ automatically.

Lighting button (2)	Dimming mode
yellow	Energy-saving lamps (CFL) ¹⁾
purple	Capacitive load
blue	Inductive load
red	LED load
green	taught-in load (CFL + LED) ¹⁾
white	automatic load setting (factory setting)

1) The load for the selected dimming mode is only taught in for approx. 30 s. This can lead to temporary impairment of the lighting.

Table 3

Displaying dimming mode

- A single press on button (2) followed by a press on button (7) of the channel concerned, allows the current dimmer mode to be consulted. The coloured lighting of the button will display the current operating mode for approx. 3 s (Table 3).

Teach in the load of an operating unit via the button

When teaching in the connected load, the dimming performance for compact fluorescent lamps and LED lamps is optimised.

The device is ready for operation. The dimming button of an operating unit has been programmed with the taught-in output.

- Press the dimming button 5 times briefly, then keep the button pressed until the load switches off.

I The short press is independent of the configured operating performance on the operating unit (5 x On, 5 x Off or 5 x On/Off).

- Press button once briefly.

The teach-in process starts. The teach-in process lasts approx. 30 s. A dimming operation is performed to optimise the dimming performance. After teaching in, the connected load lights up at maximum brightness and flashes once. The teach-in process is complete.

I Depending on the connected load, the minimum brightness may change due to the teach-in process.

Resetting taught-in loads in the device

The device can be reset to automatic load detection, e.g. after replacing illuminants.

I Automatic load detection is particularly suitable for loads that can be dimmed clearly in the phase cut-on or phase cut-off („conventional loads“).

The device is ready for operation. The dimming button of an operating unit has been programmed with the taught-in output.

- Press the dimming button 5 times briefly, then keep the button pressed until the load switches off.

I The short press is independent of the configured operating performance on the operating unit (5 x On, 5 x Off or 5 x On/Off).

I If the dimming button is no longer pressed within the next 10 seconds, the learned dimming principle is retained.

- Press button 2 times briefly.

The load flashes 2 times. The automatic load detection is enabled again.

Appendix

Technical data

Supply voltage via mains	230V~ +10/-15%
Mains frequency	240V~ +6/-6%
Energy dissipation	50/60 Hz
Supply voltage KNX/EIB	8.9 W
Current consumption KNX/EIB	21-32V = SELV
Consumption without load	2.3 mA
Upstream protection: circuit breaker	600 mW
Operating altitude	10 A
Pollution degree	2000 m. max
Surge voltage	2
Degree of protection of housing	4 kV
Degree of protection of housing under front panel	IP20
IK (impact protection)	IP30
Overvoltage class	04
Dimension	III
Connection capacity	6 modules, 6 x 17.5 mm
Operating temperature	0.75 mm ² ...2.5 mm ²
Storage temperature	-5 ...+ 45 °C
Communication media KNX	- 20 ...+ 70 °C
Configuration mode	TP 1
	S-Mode, easy link controller (TXA663A)

I Conventional and electronic transformers should not be operated with less than 75% of their nominal load.

Troubleshooting

Manual operation not possible

Cause 1: switch (1) not moved to .

Move switch to .

Cause 2: manual operation has not been enabled (Systemlink)

Enable manual operation via application software.

Connected loads to not light up

Cause 1: electronic short-circuit and overload protection has triggered, control LED (8) lights up/ flashes.

Reduce connected load, check wiring and repair if necessary.

Cause 2: overheating protection has triggered, control LED (9) lights up.

Reduce connected load, provide sufficient cooling, increase distance to adjacent devices.

Bus operation is not possible

Cause 1: bus voltage is not present.

Check bus connection terminals for correct polarity.

Check bus voltage by briefly pressing the programming button (6), red LED lights up if bus voltage is present. If mains voltage is available without bus voltage, the red LED is lit up permanently.

Cause 2: manual operation is active. Switch (1) is in position .

Move switch (1) to position **auto**.



Correct Disposal of This product (Waste Electrical & Electronic Equipment).

(Applicable in the European Union and other European countries with separate collection systems).

This marking shown on the product or its literature indicates that it should not be disposed with other household waste at the end of its working life. To prevent possible harm to the environment or human health from uncontrolled waste disposal, please separate this from other types of wastes and recycle it responsibly to promote the sustainable reuse of material resources.

Household users should contact either the retailer where they purchased this product, or their local government office, for details of where and how they can take this item for environmentally safe recycling.

Business users should contact their supplier and check the terms and conditions of the purchase contract. This product should not be mixed with other commercial wastes of disposal.

Usable in all Europe  and in Switzerland